

- ^{ぶんどき}分度器の中心を点アに合わせて次の角度をかきましょう。

1 130°

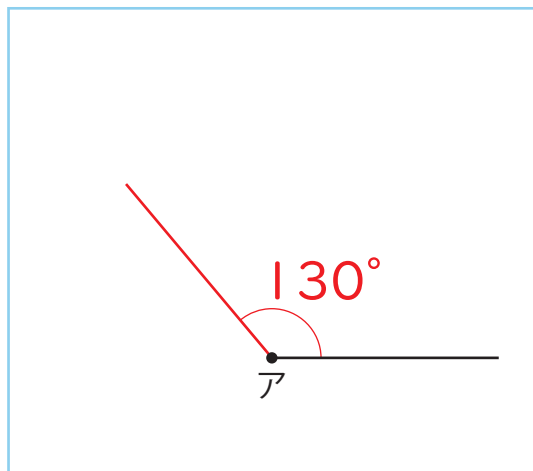

2 110°

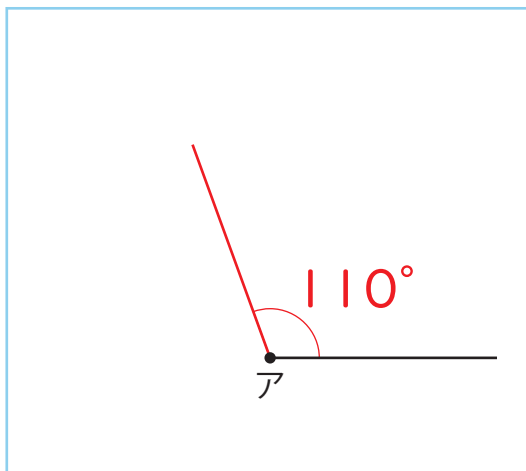

3 120°

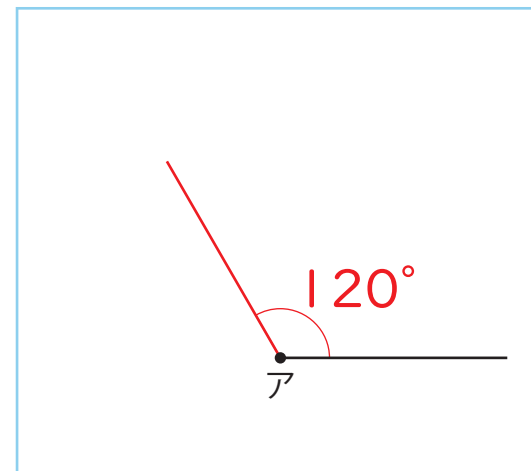

4 140°

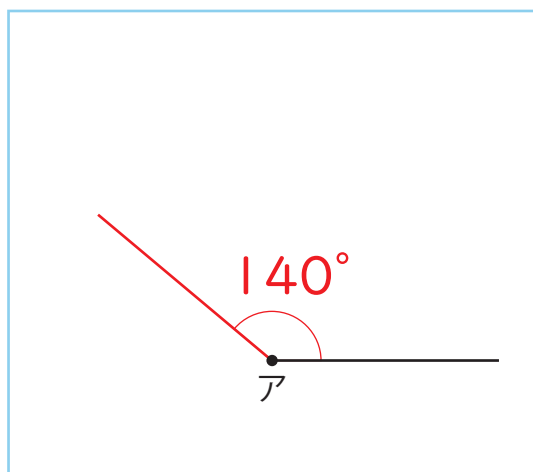

5 170°

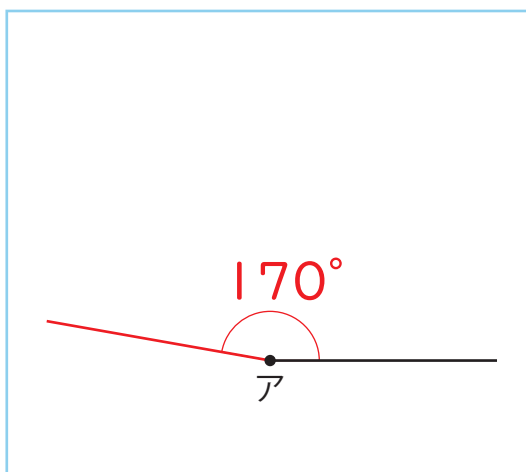

6 100°

